

uitwerkbijlage

Naam kandidaat _____ Kandidaatnummer _____

1

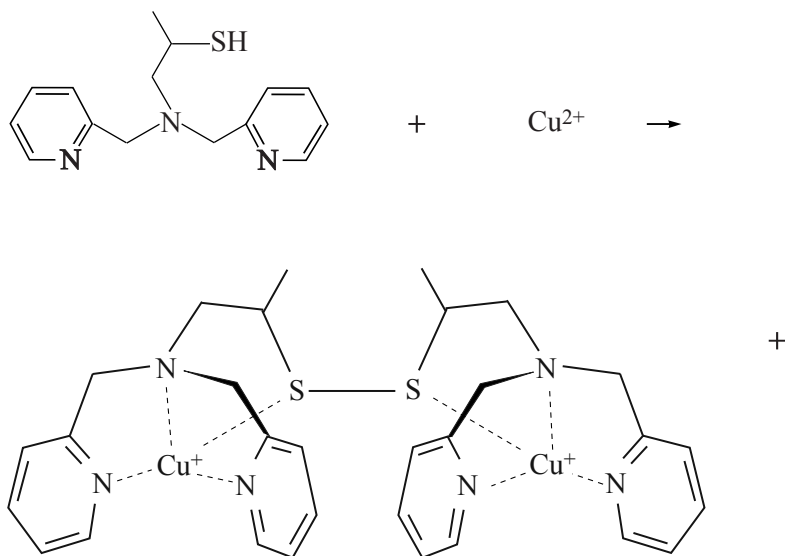

16

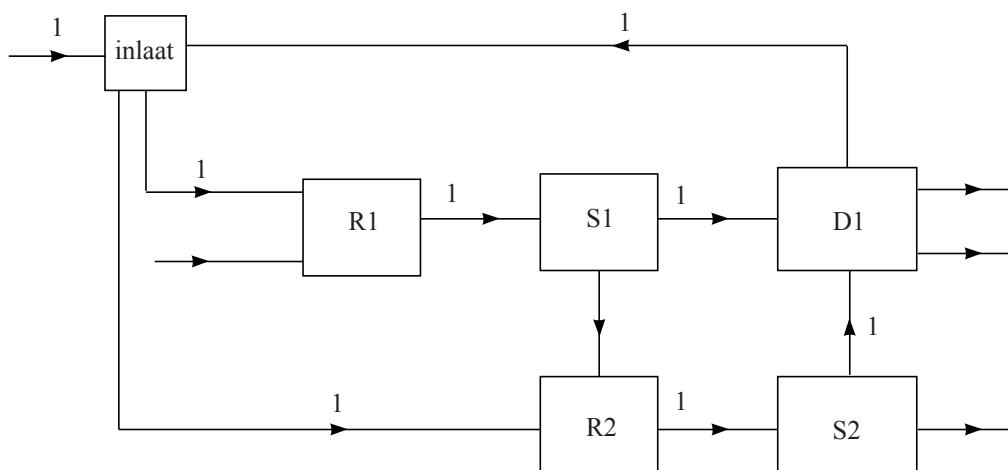

VERGEET NIET DEZE UITWERKBIJLAGE IN TE LEVEREN